

HITACHI

SOLID STATE COLOR TV

27UX01B

OPERATING GUIDE



IMPORTANT SAFEGUARDS

2-3



FIRST TIME USE

4-9



REMOTE CONTROL

10-17



SPECIAL FUNCTIONS

18-29

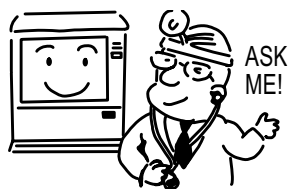



USEFUL INFORMATION

30-31

Important

Follow all warnings and instructions marked on this television receiver.

	CAUTION RISK OF ELECTRIC SHOCK DO NOT OPEN	
CAUTION: TO REDUCE THE RISK OF ELECTRIC SHOCK, DO NOT REMOVE COVER (OR BACK). NO USER SERVICEABLE PARTS INSIDE. REFER SERVICING TO QUALIFIED SERVICE PERSONNEL.		





The lightning flash with arrowhead symbol, within an equilateral triangle, is intended to alert the user to the presence of uninsulated "dangerous voltage" within the product's enclosure that may be of a sufficient magnitude to constitute a risk of electric shock to persons.



The exclamation point within an equilateral triangle, is intended to alert the user to the presence of important operating and maintenance (servicing) instructions in the literature accompanying the appliance.



CAUTION: Never remove the back cover of the set as this can expose you to very high voltages and other hazards. If the set does not operate properly, unplug the set and call your authorized dealer or service shop. To prevent fire or shock hazard, do not expose this television system to rain or moisture.

NOTE: This television receiver will display closed captioning, ( or ), in accordance with paragraph 15.119 of the FCC rules. Model and serial numbers are indicated on back side of the set.

Modifications

The FCC requires the user to be notified that any changes or modifications made to this device that are not expressly approved by Hitachi Home Electronics (America), Inc. may void the user's authority to operate the equipment.

POWER SOURCE

- This solid state color TV is designed to operate on 120 volts 60Hz, AC household current.
- Insert power cord into a 120 volt 60Hz outlet.
- To prevent electric shock, do not use the television's plug with an extension cord, receptacle, or other outlet unless the blades and ground terminal can be fully inserted to prevent blade exposure.
- Never connect the TV to 50Hz, direct current, or anything other than the specified voltage.

IMPORTANT SAFEGUARDS

SAFETY POINTS YOU SHOULD KNOW ABOUT YOUR HITACHI TELEVISION RECEIVER

- CAUTION:**
- Read all of these instructions.
 - Save these instructions for later use.
 - Follow all warnings and instructions marked on the television receiver.

Our reputation has been built on the quality, performance, and ease of service of HITACHI television receivers.

Safety is also foremost in our minds in the design of these units. To help you operate these products properly, this section illustrates safety tips which will be of benefit to you. Please read it carefully and apply the knowledge you obtain from it to the proper operation of your HITACHI television receiver.

Please fill out your warranty card and mail it at once to HITACHI. This will enable HITACHI to notify you promptly in the improbable event that a safety problem should be discovered in your product model.

FOR YOUR PERSONAL SAFETY

1. This television set is equipped with a polarized alternating-current line plug (a plug having one blade wider than the other.) This plug will fit into the power outlet only one way. This is a safety feature. If you are unable to insert the plug fully into the outlet, try reversing the plug. If the plug should still fail to fit, contact your electrician to replace your obsolete outlet. Do not defeat the safety purpose of the polarized plug.



2. When the power cord or plug is damaged or frayed, unplug the television set from the wall outlet and refer servicing to qualified service personnel.

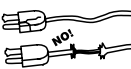

3. Do not overload wall outlets and extension cords as this can result in fire or electric shock.



4. Do not allow anything to rest on or roll over the power cord, and do not place the TV where the power cord is subject to traffic or abuse. This may result in a shock or fire hazard.



5. Do not attempt to service the television set yourself as opening or removing covers may expose you to dangerous voltage or other hazards. Refer all servicing to qualified service personnel.



6. Never push objects of any kind into the television's cabinet slots as they may touch dangerous voltage points or short out parts that could result in a fire or electric shock. Never spill liquid of any kind on the television set.

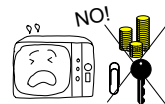

7. If the television set has been dropped or the cabinet has been damaged, unplug the television set from the wall outlet and refer servicing to qualified service personnel.

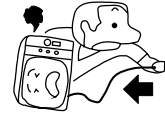

8. If liquid has been spilled into the television set, unplug it from the wall outlet and refer service to qualified service personnel.



9. Do not subject your television set to impact of any kind. Be careful not to damage the picture tube surface.



10. Unplug the television set from the wall outlet before cleaning. Use a damp cloth for cleaning. Do not use liquid or aerosol cleaners.



11-1. Do not place the television set on an unstable cart, stand, or table. The television set may fall, causing serious injury to a child or an adult, and serious damage to the appliance. Use only with a cart or stand recommended by the manufacturer, or sold with the television set. Wall or shelf mounting should follow the manufacturer's instructions, and should use a mounting kit approved by the manufacturer.



11-2. An appliance and cart combination should be moved with care. Quick stops, excessive force, and uneven surfaces may cause the appliance and cart combination to overturn.



Important

PROTECTION AND LOCATION OF YOUR TELEVISION SET

12. Do not use the television set near water, for example, near a bathtub, washbowl, kitchen sink, or laundry tub, in a wet basement, or near a swimming pool, etc.



- Never expose the set to rain or water. If the set has been exposed to rain or water, unplug set from wall outlet and refer to qualified service personnel.

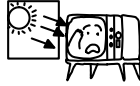

13. Choose a place where light (artificial or sunlight) does not shine directly on the screen.

14. Avoid dusty places, since accumulated dust inside the chassis may cause failure of the set when high humidity persists.



15. The set has slots or openings in the cabinet for ventilation purposes which provide reliable operation of the receiver and protect the TV from overheating. These openings must not be blocked or covered.

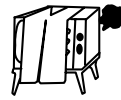

- Never cover the slots or openings with cloth or other material.

- Never block the bottom ventilation slots of the set by placing it on a bed, sofa, rug, etc.



- Never place the set near or over a radiator or heat register.



- Never place the set in a "built-in" enclosure, unless proper ventilation is provided.



PROTECTION AND LOCATION OF YOUR TELEVISION SET

16. If an outside antenna is connected to the television set, be sure the antenna system is grounded so as to provide some protection against voltage surges and built-up static charges. Section 810 of the National Electrical Code, NFPA No. 70-1975, provides information with respect to proper grounding of the mast and supporting structure, grounding of the lead-in wire to an antenna discharge unit, size of grounding conductors, location of antenna discharge unit connection to grounding electrode, and requirements for the grounding electrode.

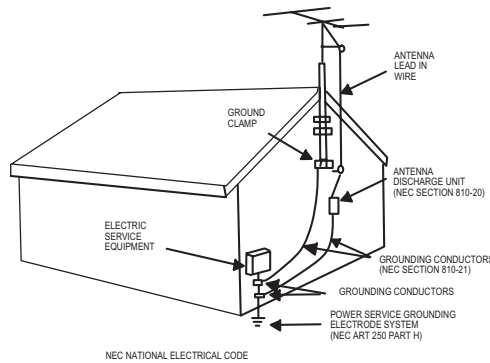

EXAMPLE OF ANTENNA GROUNDING AS PER NATIONAL ELECTRICAL CODE INSTRUCTIONS.

16-1. Note to CATV system installer: (Only for television sets with CATV reception) This reminder is provided to call CATV system installer's attention to Article 820-40 of the NEC that provides guidelines for proper grounding and, in particular, specifies that the cable ground shall be connected to the grounding system of the building, as close to the point of cable entry as practical.

17. An outside antenna system should not be located in the vicinity of overhead power lines or other electrical lights or power circuits, or where it can fall into such power lines or circuits. When installing an outside antenna system, extreme care should be taken to keep from touching such power lines or circuits as contact with them might be fatal.



18. For added protection for the television set during a lightning storm, or when it is unused for long periods of time, unplug it from the wall outlet and disconnect antenna. This will prevent damage due to lightning and power-line surges.

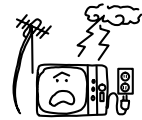

OPERATION OF YOUR TELEVISION SET

19. This television set should be operated only from the type of power source indicated on the marking label. If you are not sure of the type of power supply at your home, consult your television dealer or local power company. For television sets designed to operate from battery power, refer to the operating instructions.



20. If the television set does not operate normally by following the operating instructions, unplug the television set from the wall outlet and refer servicing to qualified service personnel. Adjust only those controls that are covered in the instructions as improper adjustment of other controls may result in damage and will often require extensive work by a qualified service technician to restore the television set to normal operation.



21. If your television set is to remain unused for a period of time, (such as when going on a holiday), turn the television set OFF and unplug it from the wall outlet.



IF THE TELEVISION SET DOES NOT OPERATE PROPERLY

22. If you are unable to restore normal operation by following the detailed procedure in your operating instructions, do not attempt any further adjustments. Unplug the set and call your dealer or service technician.



23. Whenever the television set is damaged or fails, or if there is a distinct change in performance that indicates a need for service, unplug the set and have it checked by a qualified service technician.

24. It is normal for some television sets to make occasional snapping or popping sounds, particularly when being turned on or off. If the snapping or popping is continuous or frequent, unplug the set and consult your dealer or service technician.

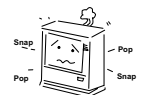

FOR SERVICING AND MODIFICATION

25. Do not use attachments not recommended by the television set manufacturer as they may cause hazards.



26. When replacement parts are required, be sure the service technician has used replacement parts specified by the manufacturer that have the same characteristics as the original part. Unauthorized substitutions may result in fire, electric shock, or other hazards.

27. Upon completion of any service or repairs to the television set, ask the service technician to perform routine safety checks to determine that the television is in safe operating condition.



Introduction

Your new television features all solid state components. It is designed to give you many years of enjoyment. It was thoroughly tested and adjusted at the factory for best performance. In order for you to take full advantage of your new television, please read and follow the installation and operating instructions contained in this manual.

Customer Record

The model and serial number of this product are located on the back of the TV. You should note the model and serial number in the space provided and retain as a permanent record of your purchase. This will aid in identification in the event of theft or loss.

Model	
Number	
Serial	
Number	

Care and Cleaning

Picture Tube (Turn TV Off)

Use a mild soap solution or window cleaner with a soft clean cloth. **DO NOT USE ABRASIVE CLEANERS.** Avoid excessive moisture and wipe dry.

Plastic Cabinets

Wipe the cabinet with a soft cloth dampened with water or a mild detergent solution and wipe dry with a soft clean cloth. Avoid excessive moisture. Do not use benzene, thinner or other petroleum based products.

Remote Control

Wipe the cabinet with a soft cloth dampened with water or a mild detergent solution and wipe dry with a soft clean cloth. Do not use benzene, thinner or other petroleum based products.

Television Location

This television is intended to be used with a stand or entertainment center. Consult your dealer for available options. Locate for comfortable viewing. Avoid placing where sunlight or other bright lights (including reflections) will fall on the screen. Use of some types of fluorescent lighting may reduce remote control transmitter range.

Adequate ventilation is essential to prevent internal component failure. Keep away from excessive heat or moisture. To ensure optimum color purity do not position magnetic equipment (motors, fans, external speakers) nearby.

Optional External Equipment Connections

The Audio/Video connections between components can be made with shielded video and audio cables. For best performance, video cables should utilize 75 ohm coaxial shielded wire. Cables are available from your dealer or electronic supply house.

Before you purchase any cables, be sure you know what type of output and input connectors your various components require. Also determine the length of cable you'll need.

AC Power Supply Cord

CAUTION: TO PREVENT ELECTRIC SHOCK, MATCH WIDE BLADE OF PLUG TO WIDE SLOT OF AC OUTLET AND FULLY INSERT. DO NOT USE A PLUG WITH A RECEPTACLE OR OTHER OUTLET UNLESS THE BLADE CAN BE FULLY INSERTED TO PREVENT BLADE EXPOSURE. FOR SOME MODELS THAT ARE NON-POLARIZED, THE USE OF AN AC ADAPTOR CONNECTOR MAY BE NECESSARY.

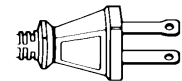

Polarized Plug

Installation

Remote Control Battery Installation

Batteries: Use two "AA" batteries.

1. Remove the battery compartment cover on back of the remote.
2. Install the batteries in the battery compartment. (Polarity (+) or (-) must be correct.)
3. Reattach the battery cover.



Battery Replacement

For frequent remote users, replace old batteries with alkaline batteries for longer life.

Precaution on Battery Use

Incorrect installation can cause battery leakage and corrosion that will damage the remote control.

Observe the Following Precautions:

1. Batteries must be replaced as a pair.
2. Do not combine a used battery with a new one.
3. Do not mix battery types (Example: "Zinc Carbon" with Alkaline").
4. Do not attempt to charge, short-circuit, disassemble, heat or burn used batteries.
5. Battery replacement is necessary when remote control reacts sporadically or stops operating the television.



Cable / Antenna

For proper reception, either a cable or antenna connection is required.

Cable Connection

Connect the cable supplied by your local cable company.

Note: *A cable converter box may be required for proper reception. Check with your local Cable company for compatibility requirements.*

Incoming cable from cable company

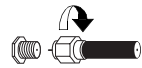



75 OHM VHF/UHF
ON BACK OF TV

Antenna Connection

- For proper reception of VHF/UHF channels, an external antenna is required. For best reception an outdoor antenna is recommended.
- Antenna must be selected as the signal source in the SET-UP menu.

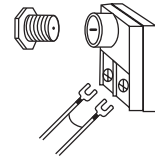
Incoming cable from home antenna





Cable Preset

Cable (CATV) mode is preset at the factory. Antenna users must change to antenna mode in the Set -Up menu.

Installation

Optional Equipment Connections

Audio / Video Connections

VCRs, video disc players, video game consoles, and SAT equipment can also be connected to the video inputs. See the optional equipment manual for details.

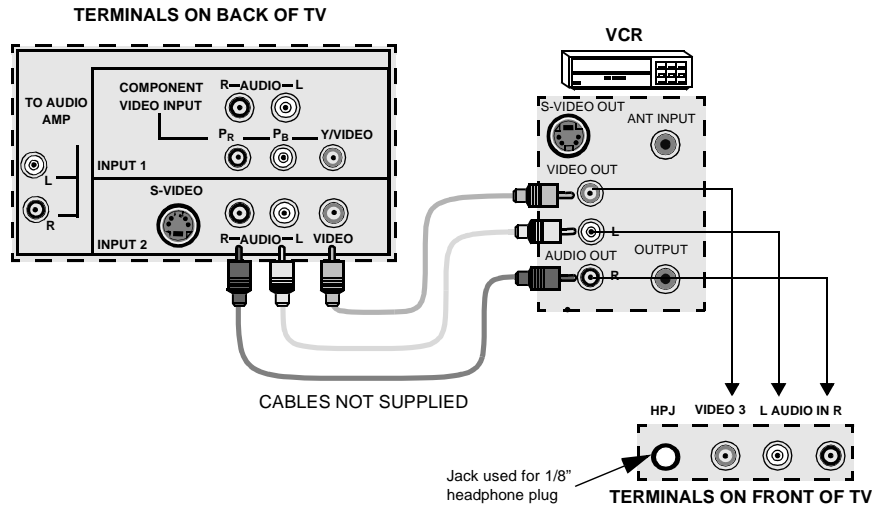

Procedure

1. Connect equipment as shown to front or rear Audio/Video input jacks.
2. Select the video mode by pressing **INPUT** button.
3. Operate optional equipment as instructed in equipment manual.

NOTE: The S-VIDEO connection is optional and overrides normal VIDEO connection. Use INPUT 2, AUDIO R and L with S-VIDEO connection.

Installation

Amplifier Connection (TO AUDIO AMP)

Connect to an external audio amplifier input for listening to TV from a stereo system speakers.

Audio Adjustments

1. Select INTERNAL SPEAKER ON located in the AUDIO menu on screen.
2. Set amplifier volume to minimum.
3. Adjust TV volume to desired level.
4. Adjust amplifier volume to match the TV.
5. Select INTERNAL SPEAKERS OFF&VAO from AUDIO menu.
6. Volume, mute, bass, treble and balance are now controlled from the TV.

Note: *TO AUDIO AMP terminals should not be connected directly to external speakers. In OFF&FAO the volume is controlled by the external amplifier.*

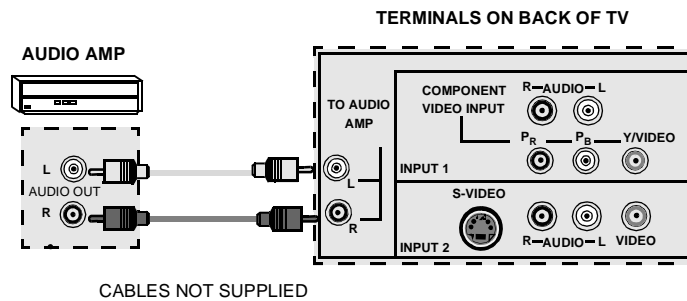

Digital TV - Set-Top Box (DTV-STB) Connection

Use this diagram to connect a DVD player or a DTV-STB (Digital TV-Set-Top Box) to the back of your TV.

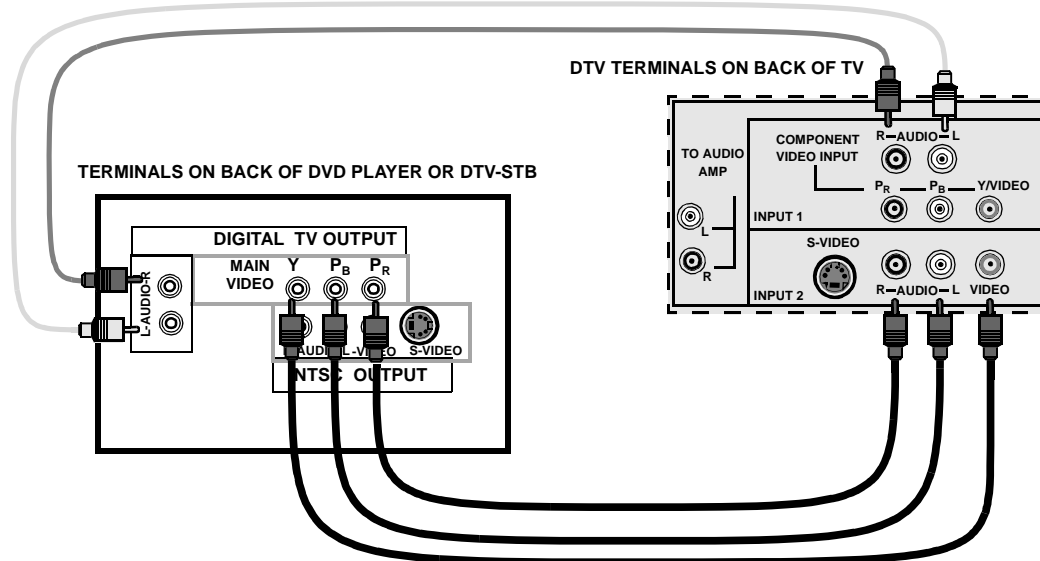

Note: *There are three video inputs, Y, P_B, and P_R. Separate component color inputs provide luminance and color separation. Use the L (left) and R (right) audio inputs.*

Picture in Picture (PIP) Operation

This television includes a two tuner Picture In Picture (PIP) feature. This allows watching two (2) live broadcasts at the same time with or without an external video source (VCR).

Without a VCR

Procedure

- Connect incoming cable to antenna (ANT) input on back of TV.
- Press the **PIP** button on the remote control to display the PIP frame.
- Choose channels for the *PIP* frame by pressing the remote control **PIP CH ▲▼** buttons.
- Choose channels for the *Main Picture* by pressing the remote control **CH ▲▼** buttons or by using the numeric keypad.

Note: *The audio is from the Main Picture only.*

With a VCR and Cable Box

Connect your television to a VCR and cable box, as shown.

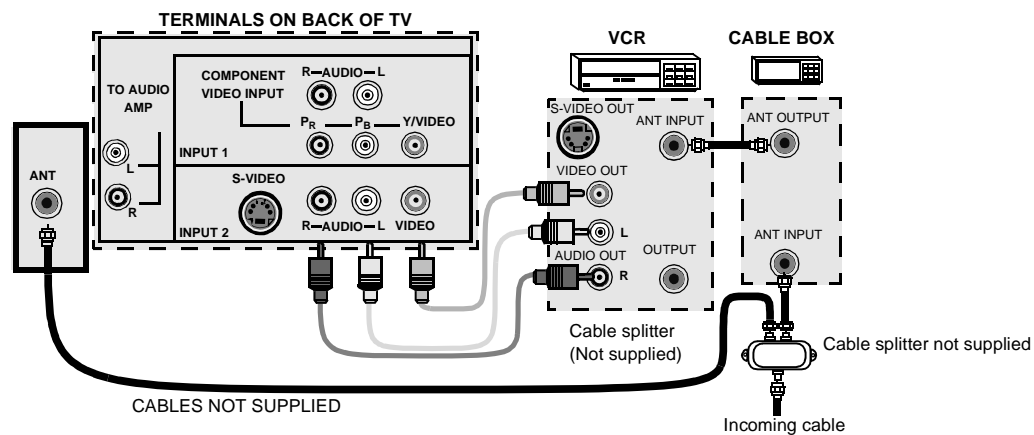

Note: *The Remote Control must be programmed with supplied codes to operate the VCR and cable box. (See "Programming the Remote" on page 16.)*

Procedure

Press the **PIP** button on the remote control to display the PIP frame.

To view scrambled channels through your cable box in the PIP frame:

- Press the **INPUT** button on the remote control to select the video input to which your VCR is connected.
- Verify the **CABLE BOX** and **VCR** are **ON** and the **VCR** tuned to channel 3 or 4.
- Choose channels for the *PIP* frame by pressing the **CABLE** button on the remote control and using the numeric keypad or **CH ▲▼** buttons.
- Choose channels for the *Main Picture* by pressing the **TV** button on the remote control and using the numeric keypad or **CH ▲▼** buttons.

Note: *The audio is from the Main Picture only.*



SWAP and RECALL Buttons

The **SWAP** button switches the PIP and the main picture source. The **RECALL** button shows the status of the onscreen PIP and the main picture.

Picture in Picture (PIP) Operation

With a VCR - No Cable Box

This television includes a two tuner Picture In Picture (PIP) feature. This allows watching two (2) live broadcasts at the same time without or with an external video source (VCR).

Connect your television to a VCR, as shown.

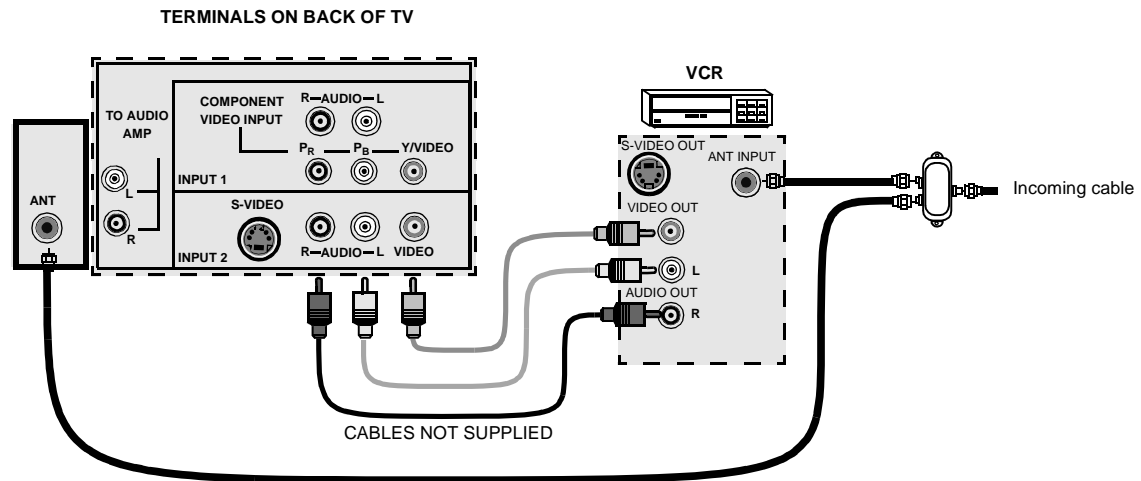

Note: *The Remote Control must be programmed with the supplied codes to operate the VCR. (See "Programming the Remote" on page 16).*

Procedure

Press the **PIP** button on the remote control to display the PIP frame.

Note: *The audio is from the Main Picture only.*

To view an external video source in the PIP frame:

- Press the **INPUT** button on the remote control to select the video input to which your **VCR** is connected.
- Verify the VCR is on.
- View the external video source in the PIP frame.
- Choose channels for the *Main Picture* by pressing the **TV** button on the remote control and using the numeric keypad or **CH ▲▼** button.









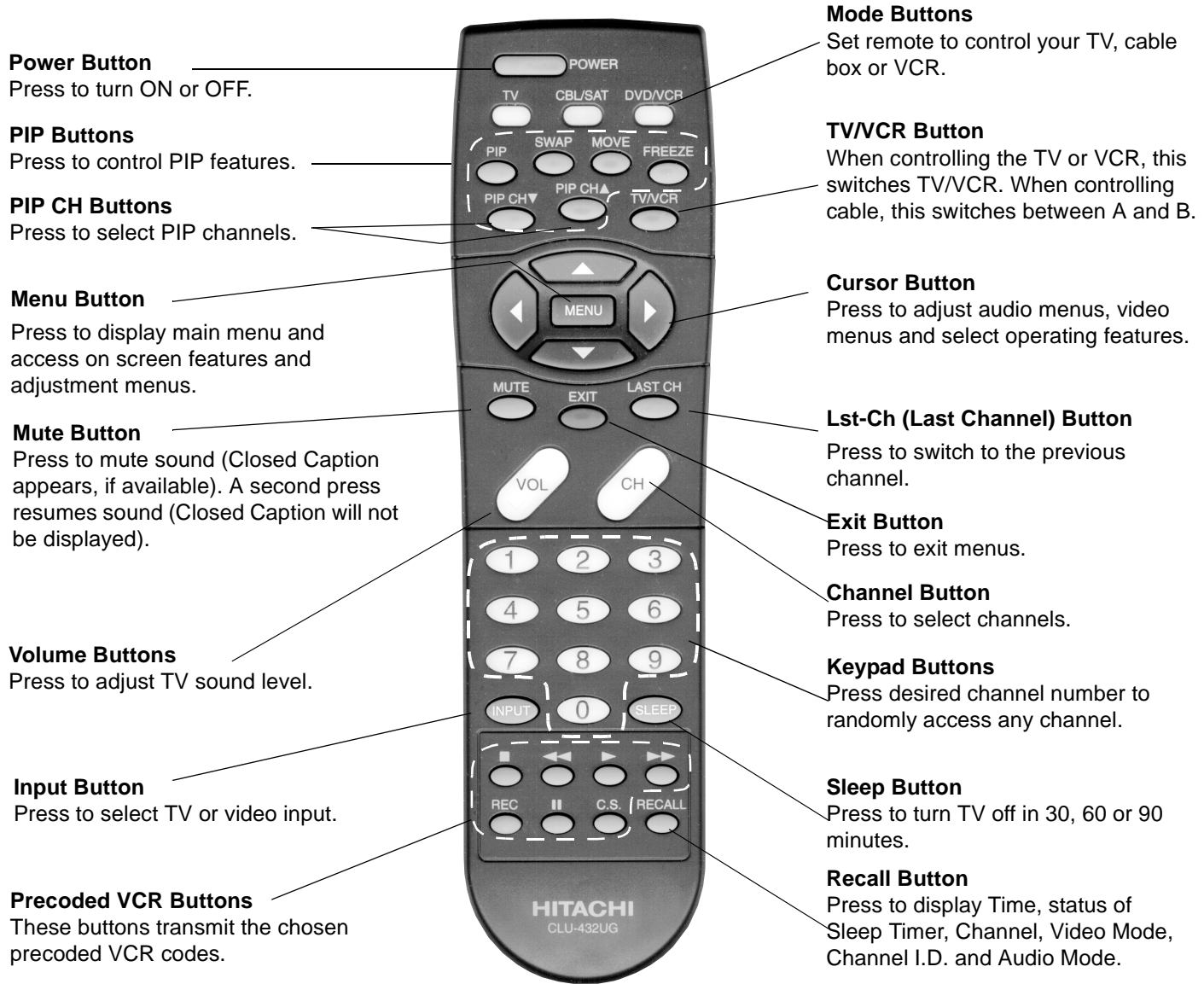



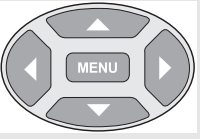



SWAP and RECALL Buttons

The **SWAP** button switches the PIP and the main picture source. The **RECALL** button shows the status of the onscreen PIP and the main picture.











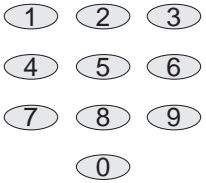

Remote Control



Quick Reference Functions Key Chart

Key	Operates	Function
POWER 	TV DVD VCR CABLE SATELLITE	Turns On and Off selected components
CURSOR BUTTONS 	TV	Menu navigation
	TV	Access menus and sub-menus
TV 	TV	TV mode selection for remote control
CBL/SAT 	CABLE SATELLITE	Cable mode selection for remote control Satellite mode selection for remote control
DVD/VCR 	DVD VCR	DVD/VCR mode selection for remote control
PIP 	TV	Displays the PIP frame, press button once more, and PIP frame becomes smaller
SWAP 	TV	Switches PIP and Main picture source
MOVE 	TV	Moves the PIP frame to one of four corners of Main picture
FREEZE 	TV	Freezes the PIP picture
PIP CH ▲▼ 	TV	Selects channels for the PIP frame
TV.VCR 	TV VCR	Selects TV or VCR mode Selects TV or VCR mode
MUTE 	TV	Mutes TV Audio
EXIT 	TV	Exits menus
LAST CH 	TV	Returns to previous channel

Quick Reference Functions Key Chart

Key	Operates	Function (Continued)
	TV	Volume up/down
	TV CABLE/ SATELLITE DVD	Channel up/down for main picture Channel up/down Previous chapter/next chapter
KEYPAD BUTTONS 	TV VCR CABLE/ SATELLITE DVD	Selects channel Selects channel Selects channel Selects chapters
	TV	Selects input mode
	TV	Selects SLEEP timer menu
STOP 	DVD VCR	Stop
	DVD VCR	Search Rewind Rewind
	DVD VCR	Play
	DVD VCR	Search Fast forward Fast Forward
REC 	VCR	Record
	DVD VCR	Pause
C.S. 	VCR	Commercial skip
RECALL 	TV	Displays channel, time, channel I.D. and audio mode

Special Buttons

Recall Button

Press the **RECALL** button to check:

1. Audio mode status
2. CH number or video input selected
3. Channel Caption (Station Identifier)
4. Clock time
5. Sleep timer status

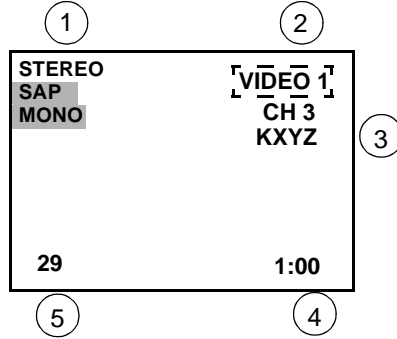

LAST-CH Button

Pressing the **LAST-CH** button will switch between the last two channels viewed.

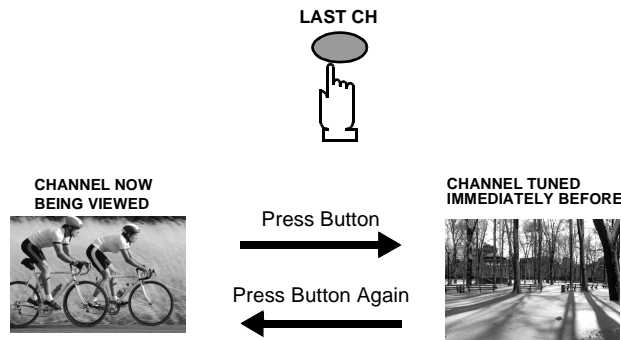

Note: When scanning channels with the **CHANNEL ▲ ▼** buttons, pressing the **LAST-CH** button will switch between the last two channels scanned.

Swap Button

Press the **SWAP** button (when the PIP frame is displayed) to interchange what is being viewed on the main picture with that of the PIP frame.

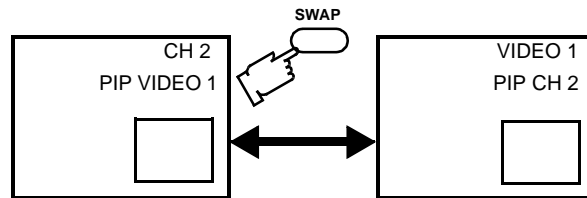

Note: The audio is from the Main Picture only.

Special Buttons

PIP (Picture in Picture) Button

This feature allows the viewer to monitor one channel program while watching another. The monitored source (PIP) can be a different channel or a different video source (such as a VCR) when connected to the input jacks.

PIP Operation

1. Press the **PIP** button (set must be ON). The PIP frame will appear at the position it was last displayed. The main picture video source and PIP video source will display on screen momentarily. Audio will be that of main picture.

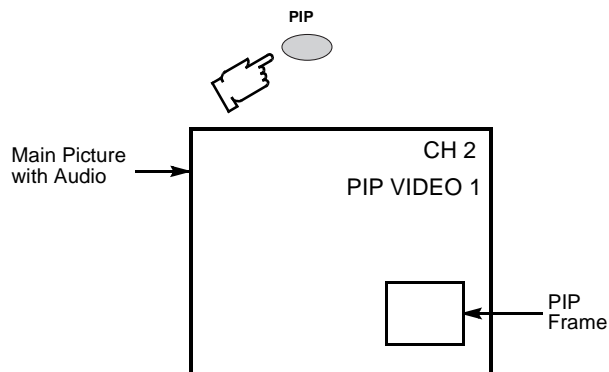

Note: *When the Main Picture is in Video mode with no signal, the PIP will not operate properly.*

2. Press the **PIP** button again to size PIP frame or twice to cancel PICTURE IN PICTURE feature.

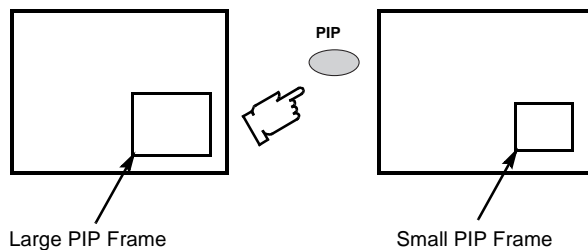

PIP CH Buttons

Press the **PIP CHANNEL ▲ ▼** button while the PIP frame is displayed to sequentially scan through channels.

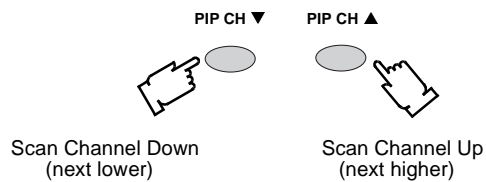

Special Buttons

Frz (Freeze) Button

Press the **FREEZE** button to stop action in the PIP frame.

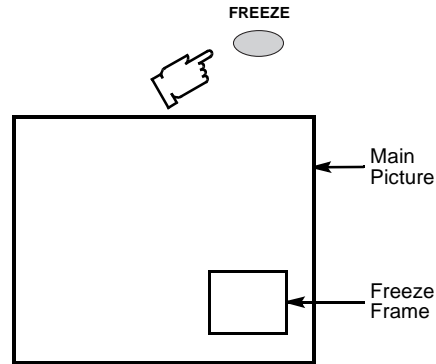

Notes:

- Pressing the **FREEZE** button when the PIP frame is not displayed, will freeze a frame from the main picture and display it in the PIP frame.
- Pressing the **FREEZE** button when the PIP frame is displayed, will freeze action from the PIP frame. Press the **FREEZE** button again to continue action.
- Press the **PIP** button as needed to delete PIP frame.

Move Button

The PIP frame may be located at any corner of the Main Picture by pressing the **MOVE** button (when the PIP frame is displayed).

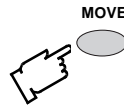

Note: *As MOVE button is pressed (when the PIP frame is displayed), the PIP frame will move counterclockwise as illustrated.*

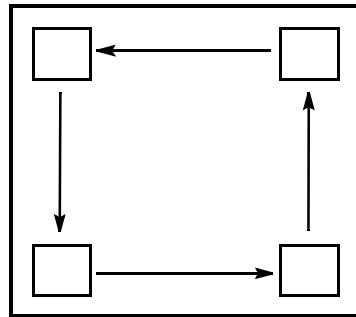

Programming the Remote

DVD/VCR Functions

This remote is designed to operate different brands of DVD players and VCRs. You must first program the remote to match the remote system of your DVD or VCR.

Procedure

1. Turn ON your DVD or VCR.
2. Aim the remote control at the front of your DVD or VCR.
3. While holding down the DVD/VCR button on the remote, enter the 2-digit preset code that matches your DVD or VCR. (See "Component Codes" on page 17) The remote will turn off your DVD or VCR when the correct 2 digit preset code is entered. When this occurs, the remote control is programmed for your DVD or VCR. If the DVD or VCR does not turn off after 25 seconds, try a different code, if available.
4. The remote will now control your DVD or VCR.

Notes

- If your DVD or VCR will not operate remotely after performing the above procedures, this means that your equipment's code has not been coded into the remote. Please consult your equipment's operating guide.
- The remote control will remember the codes you have programmed in until the batteries are removed from the remote control. After replacing the batteries repeat the programming procedure stated above.
- If your VCR does not have a remote power function, the remote will issue the CHANNEL UP function.
- The **MENU** button will act as the VCR MENU button for HITACHI VCRs.
- The **INPUT** button will act as your VCR +100 button, if required.

Cable/Satellite Box Functions

This remote is designed to operate different brands of cable boxes and Satellite boxes. You must first program the remote to match the remote system in your cable/satellite box.

Procedure

1. Turn ON your cable/satellite box.
2. Aim the remote control at the front of your cable/satellite box.
3. While holding down the **CABLE** button on the remote, enter the 2 digit preset code (See "Component Codes" on page 17) that matches your cable/satellite box. The remote will turn off your cable/satellite box when the correct 2 digit code is entered. When this occurs, the remote control is programmed for your cable/satellite box. If the cable/satellite box does not turn off after 5 seconds, try another 2 digit preset code, if available.

4. The remote will now control your cable/satellite box.

Notes

- If your cable/satellite box will not operate remotely after performing the above procedures, this means that your cable/satellite box code has not been coded into the remote. Please consult your cable/satellite box operating guide.
- The remote control will remember the codes you have programmed in until the batteries are removed from the remote control. After replacing the batteries, repeat the entire programming procedure stated above.
- If your cable/satellite box does not have a remote power function, the remote will issue the CHANNEL UP function.

Write the code numbers from tables in this space. This will serve as a reference if you need to program your remote control.		
CABLE/SATELLITE BOX <div style="border: 1px solid black; width: 40px; height: 20px; margin: 0 auto; display: flex; justify-content: space-around;"> </div>	DVD <div style="border: 1px solid black; width: 40px; height: 20px; margin: 0 auto; display: flex; justify-content: space-around;"> </div>	VCR <div style="border: 1px solid black; width: 40px; height: 20px; margin: 0 auto; display: flex; justify-content: space-around;"> </div>

Component Codes

The remote control is capable of operating many brands of VCRs and cable/satellite boxes. You must first program the remote control to match the remote system in your VCR or cable/satellite box.

Some models of VCRs or cable/satellite boxes may not remotely operate because the codes are not available due to limited memory. The remote control is not designed to control all features that are available in all models.

VCR

Brand	Code
Aiwa	48
Bell & Howell	47
Daewoo	45
Emerson	20, 21, 22, 23, 24,
Fisher	34, 37, 38, 39
GE	33
GO-VIDEO A	43
GO-VIDEO 8	44
Goldstar 8	36
Hitachi	00, 01, 02, 03, 04, 05, 06
JVC	18, 49, 50, 51
Magnavox	12, 13
Mitsubishi	27, 28, 29, 30
NEC	40, 41
Panasonic	10, 11
Philips	14
Pioneer	13, 14
Samsung	17, 25, 26
Scott	16
Sharp	31, 32
Shintom	19
Sony	07, 08, 09
Symphonic/ Teknika	42
Teknika	46
Toshiba	15
Zenith	35

SATELLITE

Brand	Code
General Instrument	30
Hitachi	29
Hughes	36
Panasonic	37
Primestar	31
RCA	32, 33, 34
RCA/Proscan	38, 39
Sony	35

DVD

Brand	Code
Hitachi	52
Panasonic	54
Pioneer	55
RCA	56
Sony	53
Toshiba	57

CABLE BOX

Brand	Code
General Instrument/ Hamlin	17
Hamlin	08, 16, 27, 49, 50
Jerrold	00, 01, 02, 03, 04, 05, 06, 07, 21
Oak	26, 27, 28
Panasonic	18, 19, 20
Pioneer	13, 14
Scientific Atlanta	8, 9, 10
Tocom	15, 16
Zenith	11, 12

Location of Television Controls



Front Control Panel

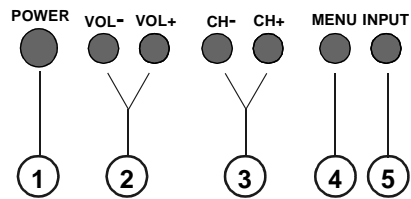

- ① **Power Button** - Press to turn ON or OFF.
- ② **VOL (Volume) Buttons** - Press to adjust sound level.
- ③ **CH (Channel)** - Press to select programmed channels.
- ④ **Menu Button** - Press to display main menu and access onscreen features or Adjustment menus.
- ⑤ **Input Button** - Press to select TV or video input.

Main Menu

Main Menu

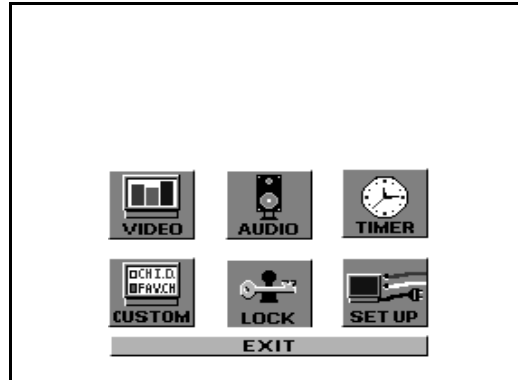

MENU Button

Press the **MENU** button to display the main menu and submenus. Press the **EXIT** button on the remote control to exit menus.



Cursor Buttons

Press the cursor buttons to select an icon, to highlight the desired features or to select and adjust features.

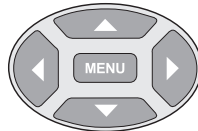

Cursor Buttons



Main Menu Feature Chart

<i>MENU</i>	<i>DESCRIPTION</i>
	SET-UP
Clock Set	Enter the time and the day of the week. (Time will display onscreen after turning on the television, pressing the RECALL button or changing channels).
Signal Source	Select Antenna or CATV to match the signal at your antenna input.
Auto Channel Set	Automatically program channels with a signal into memory.
Channel Memory	Manually add or delete channels from memory.
Closed Caption	Select C1 or C2 for Closed Captioning display. Select OFF to display closed captioning when MUTE button is pressed.
Menu Languages	Select English, Spanish or French menus.
	AUDIO
Reset	Reset BASS, TREBLE and BALANCE to factory default.
BASS	Increase or decrease the bass response.
Treble	Increase or decrease the treble response.
Balance	Emphasize the left/right speaker volume.
Mode	Select the audio mode: <ul style="list-style-type: none"> • STEREO - Two channel audio reception. • SAP - (Second Audio Program) Tune to the alternate audio channel if available in your area (bilingual or descriptive audio). • MONO - One channel audio. Use when stereo signal is weak.
Perfect Vol.	Automatically adjust volume to maintain a comfortable listening level.
Surround	Enhance audio response when listening to stereo.
Internal Speakers	Select TV SPEAKERS: <ul style="list-style-type: none"> • ON - TV SPEAKERS operate normally. • OFF&VAO (Variable Audio Output) - TV Speakers off — audio adjustable by TV. • OFF&FAO (Fixed Audio Output) - TV SPEAKERS off — audio adjustable only by the external amplifier.
	TIMER
Sleep	Program TV to automatically turn off in 30, 60 or 90 minutes. Select NO to turn timer off.
Program Event	Program TV to automatically turn on and off at selected time on a selected channel, daily or only one day.

Main Menu Feature Chart

<i>MENU</i>	<i>DESCRIPTION</i>
 VIDEO	VIDEO
Reset	Reset all picture adjustments to factory default settings.
Color	Adjust desired color intensity.
Tint	Adjust natural flesh tones.
Brightness	Adjust dark areas for crisp detail.
Contrast	Adjust white areas of picture.
Sharpness	Adjust for best clarity of outline detail.
 CHANNEL ID.	CHANNEL ID.
Channel I.D.	Provide labels for up to 30 stations using up to four characters for each station.
 LOCK	LOCK
Quick Lock	Program to prevent video games, cable box, and VCRs from being viewed.

Menu Selections

SET-UP



Language

The MENU LANGUAGE is factory set to ENGLISH. Follow the instructions to change the language menu to ESPAÑOL, FRANÇAIS or ENGLISH.

1. Press **MENU**.
2. Press cursor **▲** or **▼** and **◀** or **▶** to highlight the SET UP icon.
3. Press **MENU** to display the SET UP menu.

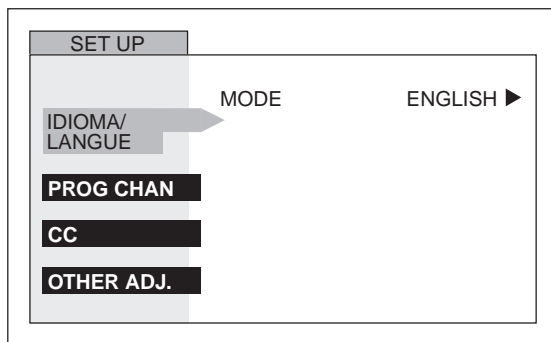

4. Press cursor **▲** or **▼** to highlight IDIOMA/LANGUE.
5. Press cursor **▶** to select ENGLISH, FRANÇAIS or ESPAÑOL.
6. Press **EXIT** to exit menu.

Signal Source

The proper input mode must be selected for the type of signal at the antenna input.

- Antenna mode is used when the receiver is not connected to a cable TV system, for example when using a VHF/UHF antenna (channels 02 - 69).
- CATV mode is used when the Receiver is connected to a cable TV system and you are not using a cable company converter box (channels 01 - 125).

Note: *This feature is disabled when LOCK SET is activated.*

1. Press **MENU**.
2. Press cursor **▲** or **▼** and **◀** or **▶** to highlight the SET UP icon.

3. Press **MENU** to display the SET-UP menu.

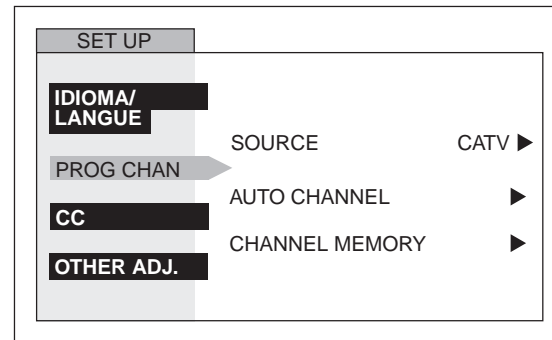

4. Press cursor **▼** highlight PROG CHAN.
5. Press cursor **◀** or **▶** to select ANTENNA (TV) or CATV.
6. Press **EXIT** to exit menu.

Auto Channel Set

This feature places all channels with a video signal into channel scan memory.

Note: *This feature is disabled when Lock Set is activated.*

1. Press **MENU**.
2. Press cursor **▲** or **▼** and **◀** or **▶** to highlight the SET-UP icon.
3. Press **MENU** to display the SET-UP menu.

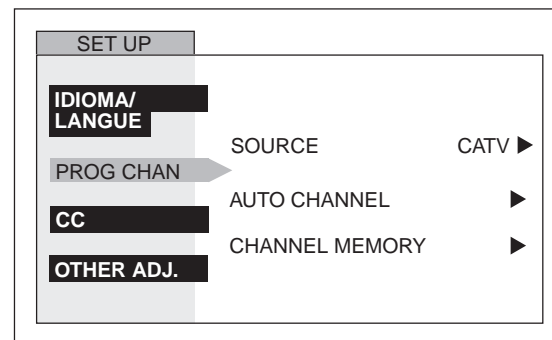

4. Press cursor **▼** to highlight PROG CHAN.
5. Press cursor **▼** to highlight AUTO CHANNEL.
6. Press cursor **◀** or **▶** start AUTO Programming. Channels will automatically advance until all channels have been scanned.
7. Press **EXIT** after completion of AUTO Programming to exit menu.

Note: *Channel numbers with blue color, indicate they are stored in channel scan memory.*

Menu Selections

Channel Memory

This feature allows you to select which channels are placed into channel scan memory.

1. Press **MENU**.
2. Press cursor **▲** or **▼** and **◀** or **▶** to highlight the SET UP icon.
3. Press **MENU** to display the SET-UP menu.

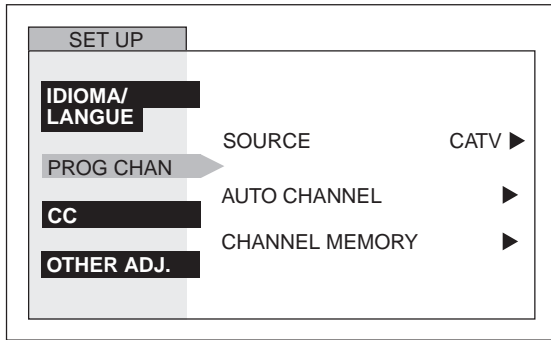

4. Press cursor **▼** to highlight PROG CHAN.
5. Press cursor **▼** to highlight CHANNEL MEMORY.
6. Press cursor **◀** or **▶** to display the CHANNEL MEMORY menu.

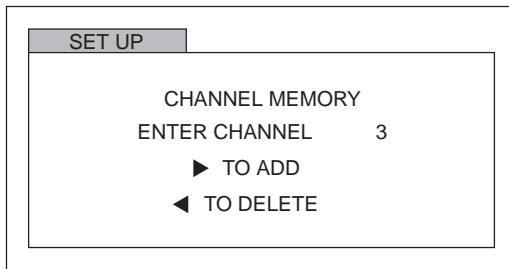

7. Use the cursor **▲** or **▼** or the remote keypad "0 through 9" buttons to select channels.
8. Press cursor **▶** to **add** channel(s) to memory. Press cursor **◀** to **delete** channels from memory.
9. Repeat steps 7 and 8 to continue adding or deleting channels.
10. Press **EXIT** to exit menu.

Note: *This feature is disabled when Lock Set is activated.*

CC on Mute

Activate C1-C2 for Closed Captioning display when the remote MUTE button is pressed.

1. Press **MENU**.
2. Press cursor **▲** or **▼** and **◀** or **▶** to highlight the SET UP icon.
3. Press **MENU** to display the SET-UP menu.

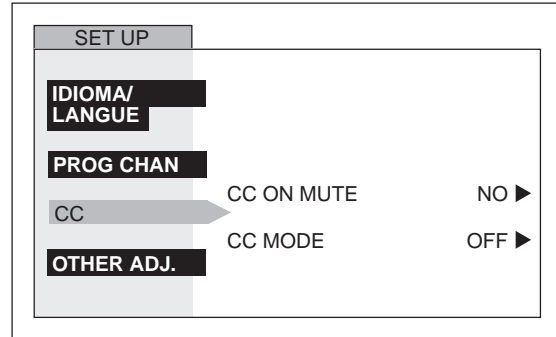

4. Press cursor **▼** to highlight **CC** (CLOSED CAPTION).
5. Press cursor **◀** or **▶** to select NO, C1, or C2.
6. Press **EXIT** to exit menu.

Closed Caption

This receiver has a built in decoder that provides a visual depiction of the audio portion of a television program. It allows the viewer to read the dialogue of a television program or other information.

1. Press **MENU**.
2. Press cursor **▲** or **▼** and **◀** or **▶** to highlight the SET-UP icon.
3. Press **MENU** to display the SET-UP menu.

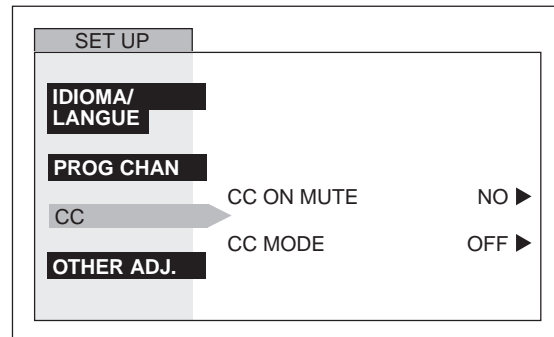

4. Press cursor **▼** to highlight **CC** (CLOSED CAPTION).
5. Press cursor **▼** to highlight CC MODE.
6. Press cursor **▶** to select OFF, C1, or C2.
7. Press **EXIT** to exit menu.

Menu Selections

Auto Power On

This feature allows the user to power up the TV at the same time as the cable box (or other components). Of course, the TV must be plugged into the cable box.

Note: *When this feature is activated (on), Timer features will be disabled.*

1. Press **MENU**.
2. Press cursor **▲** or **▼** and **◀** or **▶** to highlight the SET UP icon.
3. Press **MENU** to display the SET UP menu.

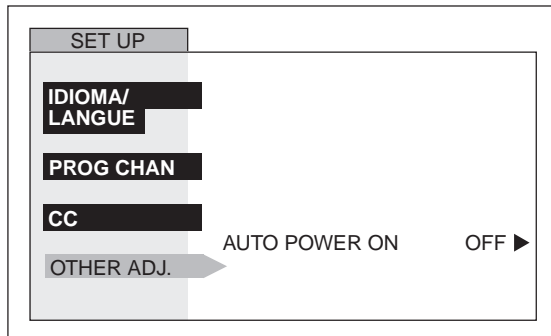

4. Press cursor **▲** or **▼** to highlight OTHER ADJ.
5. Press cursor **▶** to highlight AUTO POWER ON.
6. Press cursor **▶** to select OFF or SET.
7. Press **EXIT** to exit menu.

VIDEO



Color, Tint, Brightness, Contrast, and Sharpness

1. Press **MENU**.
2. Press cursor **▲** or **▼** and **◀** or **▶** to highlight VIDEO icon.
3. Press **MENU** to display the VIDEO menu.

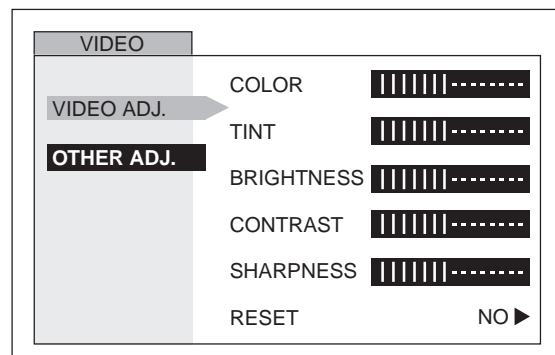

4. Press cursor **▶** to highlight COLOR.
5. Press cursor **▲** or **▼** to select the desired adjustment (color, tint, brightness, contrast, or sharpness).
6. Press cursor **◀** or **▶** to adjust your selection. (The selected picture adjustment will be displayed.)

7. Repeat steps 5 and 6 for the remaining Video Adjustments.
8. Press **EXIT** to exit menu.

Reset

Use to reset Color, Tint, Brightness, Contrast, and Sharpness adjustments back to a factory preset level.

1. Press **MENU**.
2. Press cursor **▲** or **▼** and **◀** or **▶** to highlight VIDEO icon.
3. Press **MENU** to display the VIDEO menu.

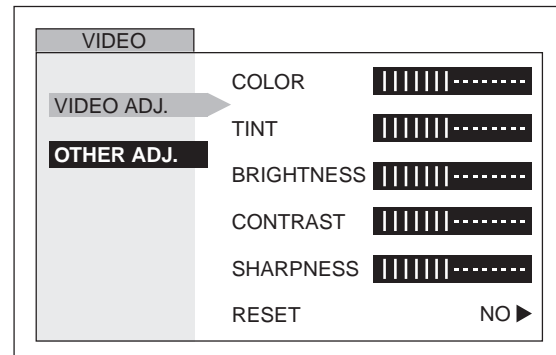

4. Press cursor **▶** to highlight COLOR.
5. Press cursor **▼** to highlight RESET.
6. Press cursor **◀** or **▶** to select RESET to normalize color, tint, brightness, contrast, and sharpness.
7. Press **EXIT** to exit menu.

Color Temperature

Use to increase and decrease Warm (red) and Cool (blue) colors to suit personal preferences.

1. Press **MENU**.
2. Press cursor **▲** or **▼** and **◀** or **▶** to highlight VIDEO icon.
3. Press **MENU** to display the VIDEO menu.

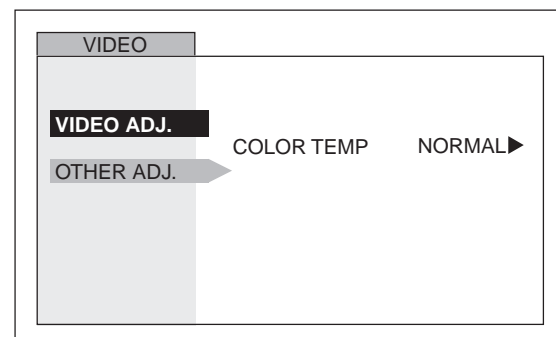

4. Press cursor **▲** or **▼** to highlight OTHER ADJ.
5. Press cursor **◀** or **▶** to select NORMAL, WARM or COOL.
6. Press **EXIT** to exit menu.

Menu Selections

AUDIO



Mode (Stereo/SAP/Mono)

When Audio is broadcast in Stereo or SAP, an on-screen display will appear on initial "Turn On" and "Channel Change". The available choices will be highlighted.

1. Press **MENU**.
2. Press cursor **▲** or **▼** and **◀** or **▶** to highlight AUDIO icon.
3. Press **MENU** to display the AUDIO menu.

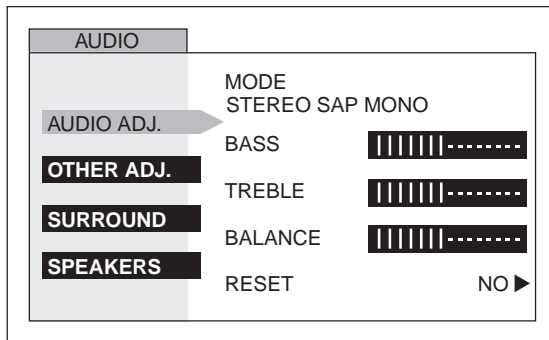

4. Press cursor **◀** or **▶** to select STEREO, SAP (Second Audio Programming), or MONO. The selected mode will be highlighted.
5. Press **EXIT** to exit menu.

Bass, Treble, and Balance

- **BASS** - To increase or decrease bass response.
- **TREBLE** - To increase or decrease treble response.
- **BALANCE** - To emphasize LEFT / RIGHT speaker volume.

1. Press **MENU**.
2. Press cursor **▲** or **▼** and **◀** or **▶** to highlight AUDIO icon.
3. Press **MENU** to display the AUDIO menu.

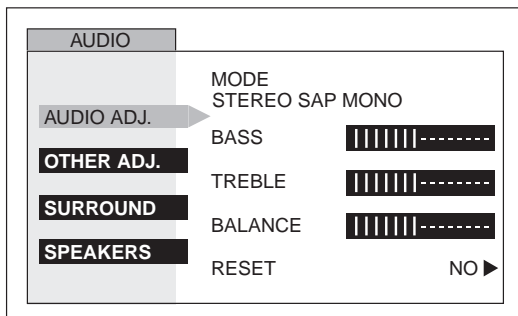

4. Press cursor **▲** or **▼** to highlight BASS, TREBLE, or BALANCE.
5. Press cursor **◀** or **▶** to adjust for desired audio response.
6. Press **EXIT** to exit menu.

Reset

This feature is used to reset BASS, TREBLE, and BALANCE back to a factory preset level.

Note: *Bass and Treble is automatically set when PERFECT VOL. (VOLUME) is ON.*

1. Press **MENU**.
2. Press cursor **▲** or **▼** and **◀** or **▶** to highlight AUDIO icon.
3. Press **MENU** to display the AUDIO menu.

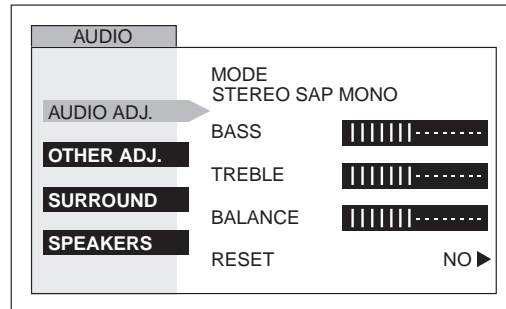

4. Press cursor **▲** or **▼** to highlight RESET.
5. Press cursor **▶** to select SET to normalize Bass, Treble, and Balance.
6. Press **EXIT** to exit menu.

Perfect Vol. (Volume)

This feature automatically adjusts the volume to maintain a comfortable listening level.

1. Press **MENU**.
2. Press cursor **▲** or **▼** and **◀** or **▶** to highlight AUDIO icon.
3. Press **MENU** to display the AUDIO menu.

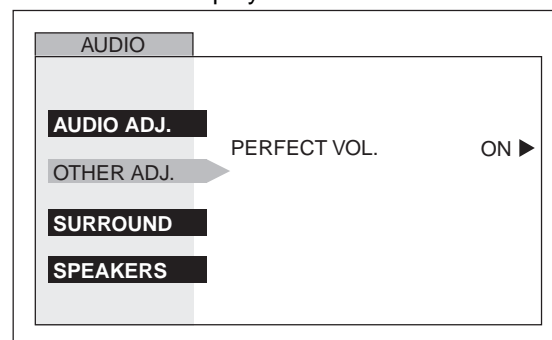







4. Press cursor **▲** or **▼** to highlight OTHER ADJ.
5. Press cursor **◀** or **▶** to select ON or OFF.
6. Press **EXIT** to exit menu.





Menu Selections

Surround

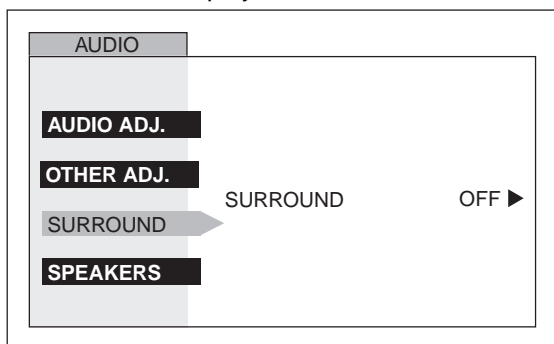
Use Surround to enhance audio response when listening to stereo broadcasts.







1. Press .
2. Press cursor  or  and  or  to highlight AUDIO icon.
3. Press  to display the AUDIO menu.







4. Press cursor  or  to highlight Surround.
5. Press cursor  or  to select ON or OFF.
6. Press  to exit menu.

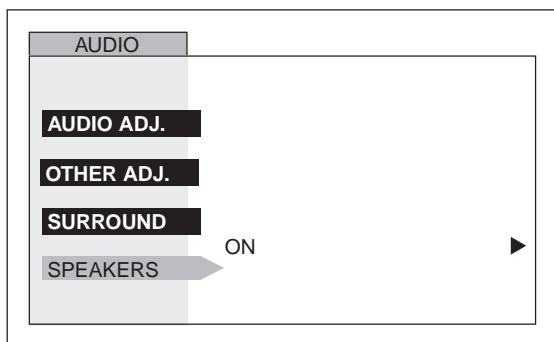

Speakers (Internal)

This feature is used to turn the internal speakers "ON" or "OFF". It is used when the TV is connected to an External Audio Amplifier. (Refer to "To Audio Amp Connection" section for further information.)

1. Press .
2. Press cursor  or  and  or  to highlight AUDIO icon.
3. Press  to display the AUDIO menu.



4. Press cursor  or  to highlight SPEAKERS.
5. Press cursor  or  to select ON, OFF&VAO or OFF&FAO.

6. Press cursor  or  to select ON, OFF&VAO or OFF&FAO.
 - ON - TV SPEAKERS operate normally.
 - OFF&VAO (Variable Audio Output) - TV SPEAKERS off, the sound output varies according to the TV volume. Use the TV remote to control the volume, muting, bass, treble, and balance of the External Amplifier System.
 - OFF&FAO (Fixed Audio Output) - TV SPEAKERS off, sound output is not adjustable. The audio is controlled by the External Amplifier System volume control.
7. Press  to exit menu.









TIMER







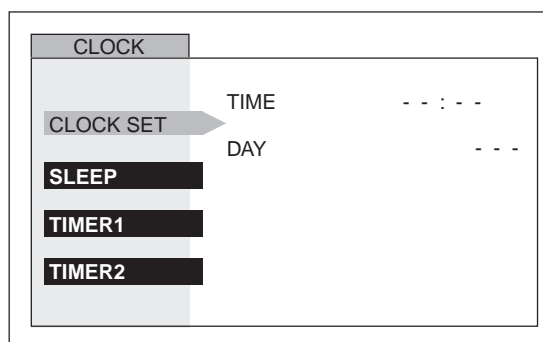

Clock Set

Clock (when set) will display onscreen at initial "Turn On", after a channel change and when pressing the RECALL button. The time must be set in order to use the program timer.

Note: *This feature will be disabled when Auto Power On is activated.*

1. Press .
2. Press cursor  or  and  or  to highlight the TIMER icon.
3. Press  to display the TIMER menu.



4. Press cursor  or  to set hours (set AM/PM) accordingly.
5. Press cursor  to select minutes position.
6. Press cursor  or  repeatedly to set minutes.
7. Press cursor  to highlight DAY.
8. Press cursor  or  to select day.
9. Press  to exit menu.

Menu Selections

Sleep

This feature is used for automatic turn off in 30, 60, or 90 minutes. Display will flash 3, 2, and 1 to indicate the last three remaining minutes prior to turn off. The Recall display will also appear.

Note: *This feature will be disabled when Auto Power On is activated.*

1. Press **MENU**.
2. Press cursor **▲** or **▼** and **◀** or **▶** to highlight TIMER icon.
3. Press **MENU** to display the CLOCK menu.

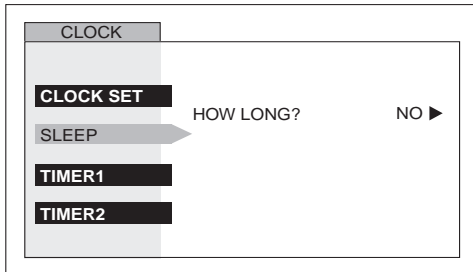

4. Press cursor **▲** or **▼** to highlight SLEEP.
 5. Press cursor **▶** to select NO, 30, 60 or 90 minutes (Sleep Timer will be activated).
 6. Press **EXIT** to exit menu.
- To deactivate Sleep Timer, repeat steps 1 through 5. In step 5, select "NO" instead of minutes.**

NOTE: SLEEP

Press the RECALL button to display the remaining minutes for Sleep. The status appears in the bottom left corner.

Timer 1 and Timer 2

In CLOCK menu, select one or both timers to turn the television on and off at selected times, on selected channels, and on selected days.

Note: *TIME must be entered in CLOCK SET to operate TIMER features*

1. Press **MENU**.
2. Press cursor **▲** or **▼** and **◀** or **▶** to highlight the TIMER icon.
3. Press **MENU** to display the CLOCK menu.

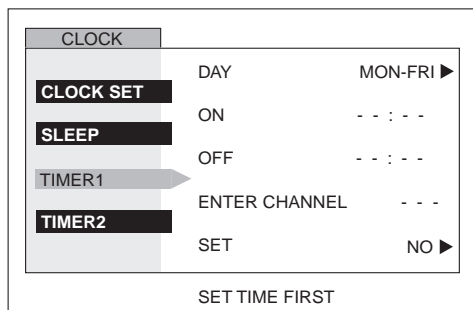

Timer 1 and Timer 2 (Cont.)

4. Press cursor **▲** or **▼** to highlight TIMER 1 or TIMER 2.
5. Press cursor **◀** or **▶** to select DAY.
6. Press cursor **▼** to highlight ON (time).
7. Press cursor **◀** or **▶** to set hours (set AM/PM).
8. Press cursor **▼** to select minutes position.
9. Press cursor **◀** or **▶** repeatedly to set minutes.
10. Press cursor **▼** to highlight OFF (time) and repeat steps 7~9.
11. Press cursor to highlight ENTER CHANNEL.
12. Press cursor **◀** or **▶** or use the remote control keypad to enter the desired channel number.
13. Press cursor **▼** to highlight SET.
14. Press cursor **▶** to select YES or NO.
15. Press **EXIT** to exit menu.

Note: Turn Off After 90 Minutes

The TV automatically turns OFF after 90 minutes when turned on by the TIMER. If the OFF time is selected or if a key is pressed, the automatic OFF after 90 minutes will be cancelled.

Note: TIMER Activation

The TIMER is active when the TV is OFF or ON. The TV will switch to the selected channel at the selected time set in the TIMER.

Note: *To deactivate program timer select no in step 13.*



CUSTOM

Custom Favorites

In CHANNELS menu under FAVORITES select:

- CHANNEL SCAN FAV to enter up to 16 favorite channels.
- CHANNEL SCAN ALL to scan all channels when using the CH up/down buttons.

1. Press **MENU**.
2. Press cursor **▲** or **▼** and **◀** or **▶** to highlight CUSTOM icon.
3. Press **MENU** to display the CUSTOM menu.

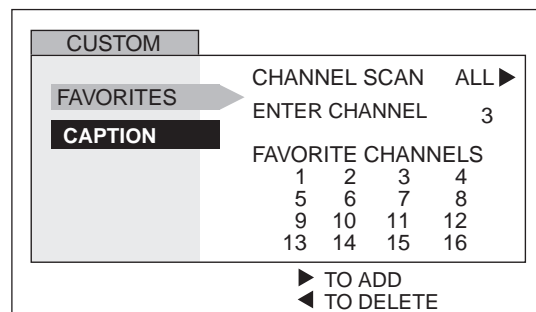



4. Press cursor **◀** or **▶** to select ALL or FAVORITES.
5. If FAVORITES selected, press cursor **▼** to highlight ENTER CHANNEL.

Menu Selections

- Use the numeric keypad on the remote control or cursor ▲ or ▼ to select channel number.
- Press cursor ► to **add** a channel and the cursor ◀ to **delete** a channel from FAVORITES.
- Repeat steps 7~8 to add or delete channels.
- Press  to exit menu.

Manual Caption

This features allows you to enter the call names of up to 30 stations into memory (using up to 4 characters for each station). The call name will then display along with the channel number when changing channels or pressing RECALL.

- Press .
- Press cursor ▲ or ▼ and ◀ or ► to highlight CUSTOM icon.
- Press  to display the CUSTOM menu.

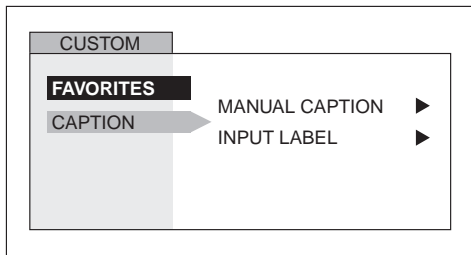

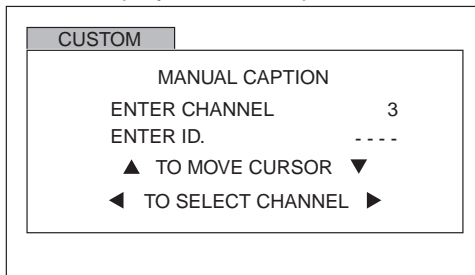

- Press cursor ▲ or ▼ to highlight CAPTION.
- Press cursor ► to highlight Manual Caption.
- Press ► to display Manual Caption sub menu.



- Press cursor ◀ or ► to enter channel number.
- Press cursor ▼ to highlight ENTER ID.
- Press cursor ► to highlight first character.
- Press cursor ◀ or ► to enter first character, then repeat until all characters are entered.
- Press ▲ or ▼ highlight ENTER CHANNEL.
- Repeat steps 7~11 to continue adding Station Identifiers.
- Press  to exit menu.

Note: *To delete* a Manual Caption Channel I.D. (station Identifier) from memory, all four characters positions in the "ENTER CAPTION" area must display a dash mark (-).

Input Label

- Press .
- Press cursor ▲ or ▼ and ◀ or ► to highlight CUSTOM icon.
- Press  to display the CUSTOM menu

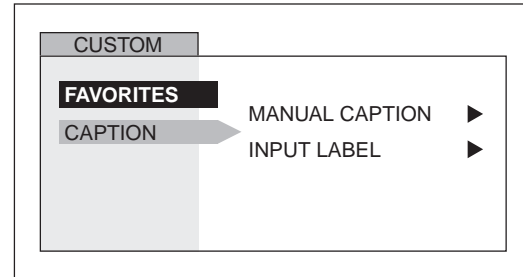

- Press cursor ▲ or ▼ to highlight CAPTION.
- Press cursor ▼ to highlight INPUT LABEL
- Press cursor ► to display Input Label sub menu..

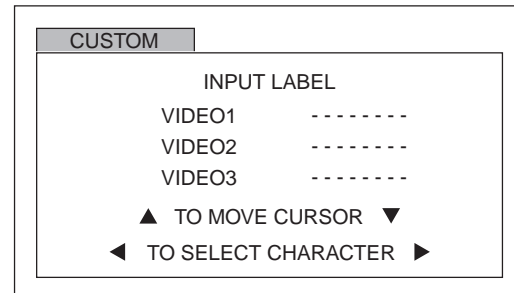

- Press cursor ▲ or ▼ highlight VIDEO 1, VIDEO 2 or VIDEO 3.
- Press cursor ◀ or ► to enter first character, then repeat until all characters are entered.
- Press  to exit menu.

Menu Selections

LOCK



Lock Set

Prevents video games and other video sources from being viewed. Channel 3, 4, and video inputs are locked out for 12, 24, 48 hours or.

Note: *Understand how to unlock Lock Set before using it. Use a code that is easy to remember or record it in a safe place.*

1. Press .
2. Press cursor or and or to highlight LOCK icon.
3. Press to display Lock menu.

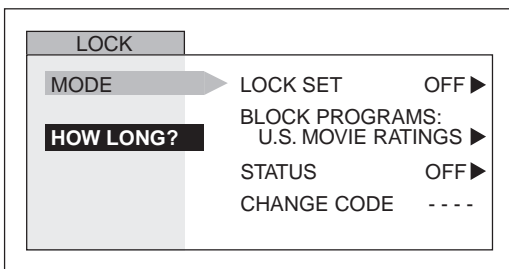

4. "ENTER SECRET CODE" should already be highlighted. Use the numeric keypad to enter a four digit code.
5. Press cursor or to display Lock Set sub menu.

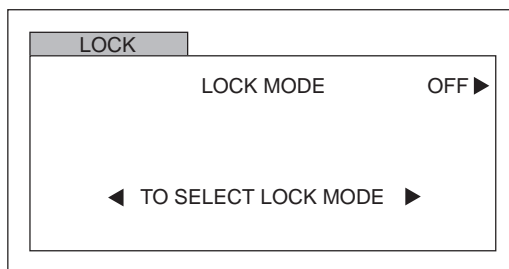

6. Press cursor to select :
 - OFF - To turn lock function off.
 - ALL - To lock all channels and video inputs.
 - CHANNEL - To lock up to four channels of your choice.
 - GAME - To lock channels 3, 4 and video inputs.
7. Press cursor to return to LOCK menu.
8. Press , then press cursor to highlight HOW LONG?
9. Press cursor to select the desired amount of time (12, 24, 48 hours or ALWAYS) for Lock Set to be activated.
10. Press to exit menus.

To unlock Lock Set follow steps 1 through 6, and on step 6 select OFF.

NOTE:

If you do not remember your code, LOCK will unlock in 12, 24, or 48 hours, depending on the current setup. Be cautious when selecting ALWAYS. If ALWAYS is selected and you forget your secret code, the TV must be serviced by a qualified technician to clear the LOCK setup.















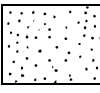

Note: *If Lock Set is selected, and if a blocked channel or video input is selected, the message "Locked" displays on the TV screen.*

For more information about Movie Rating , TV Rating and Canadian Ratings, see Hitachi Child Lock reference guide.

Useful Information

Troubleshooting Chart

Before you call for service, determine the symptoms and make a few simple checks shown below.

Symptoms		Check
Picture	Sound	
 SNOWY PICTURE	 NOISY SOUND	<ul style="list-style-type: none"> - ANTENNA LOCATION AND/OR CONNECTION
 MULTIPLE IMAGE	 NOISY SOUND	<ul style="list-style-type: none"> - ANTENNA DIRECTION AND/OR LOCATION - ANTENNA LEAD-IN WIRE
 INTERFERENCE	 NOISY SOUND	<ul style="list-style-type: none"> - ELECTRICAL APPLIANCES, LIGHTS, CARS, AND TRUCKS - DIATHERMY AND OTHER MEDICAL EQUIPMENT
 NORMAL PICTURE	 NO SOUND	<ul style="list-style-type: none"> - VOLUME CONTROL SETTING - MUTE CONTROL (IF APPLICABLE) - TRY ANOTHER CHANNEL - TV SPEAKERS OFF
 NO VIDEO	 NOISY SOUND	<ul style="list-style-type: none"> - TV OR CABLE TUNING MODE SET TO PROPER SETTING - ANTENNA INPUT CORRECT (IF APPLICABLE)
 NO PICTURE	 NO SOUND	<ul style="list-style-type: none"> - CHECK THAT AC POWER CORD IS PLUGGED INTO AC OUTLET - BRIGHTNESS AND AUDIO CONTROLS SET PROPERLY - TRY ANOTHER CHANNEL
 NO COLOR	 NORMAL SOUND	<ul style="list-style-type: none"> - COLOR CONTROL SETTINGS - TRY ANOTHER CHANNEL
 BLACK PICTURE	 NO SOUND	<ul style="list-style-type: none"> - RECEIVER IN VIDEO MODE WITH NO SIGNAL

Specifications

27UX01B	120 AC, 60 Hz
Channel Capability - 181	VHF-12; UHF-56; CABLE-113
3 Video Input Jacks	1 Vp-p, 75 Ohm, Phono Jack Type
6 Audio Input Jacks	500mV RMS 47K Ohm
Component Input (Y, P_B, P_R)	75 Ohm, Phono Jack Type
To Audio AMP Jacks	0-2.0V RMS 4.7K Ohm
S-VHS Input Jack	S-Video (Y-C) Connector

Specifications are subject to change without notice or obligation.

Useful Information

*Service
hotline*

To locate an authorized HITACHI service facility in the continental U.S.A. and Canada,

DIAL TOLL FREE

7 days a week, 24 hours a day

800 HITACHI
(1-800-448-2244)

**HITACHI AMERICA, LTD.
HOME ELECTRONICS DIVISION**

Hitachi has made every effort to assure you hours of trouble free operation from your unit, however, should your television require service, a network of Hitachi Authorized Service Facilities has been established in all 50 states and Puerto Rico. Each facility will provide convenient and expedient assistance. Our service hotline operator will direct you to the Hitachi Authorized Service Facility nearest you. Just present proof of purchase and/or delivery receipts to the Hitachi Authorized Service Facility, and service will be rendered in accordance with the terms of the limited warranty as stated on your warranty card or operating guide.

Should you have any questions regarding warranty service, operation or technical assistance, please contact:

**Hitachi Home Electronics (America), Inc.
1855 Dornoch Court
San Diego, CA 92154-3225**

***In Canada, please contact : 1- 800 - HITACHI
(1- 800 - 448-2244)***

Hitachi (HSC) Canada Inc.
6740 Campobello Road
Mississauga, Ont. L5N 2L8



HITACHI

